

01

02

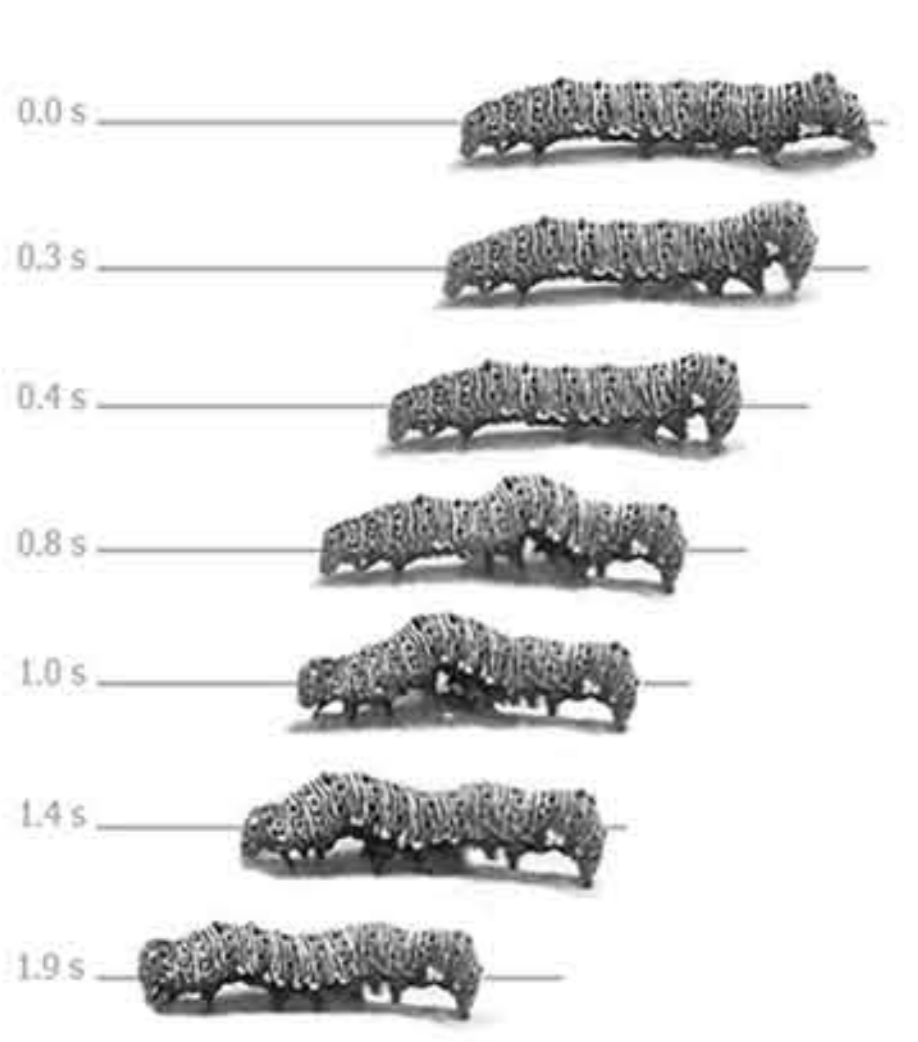

DESPLAZAMIENTO

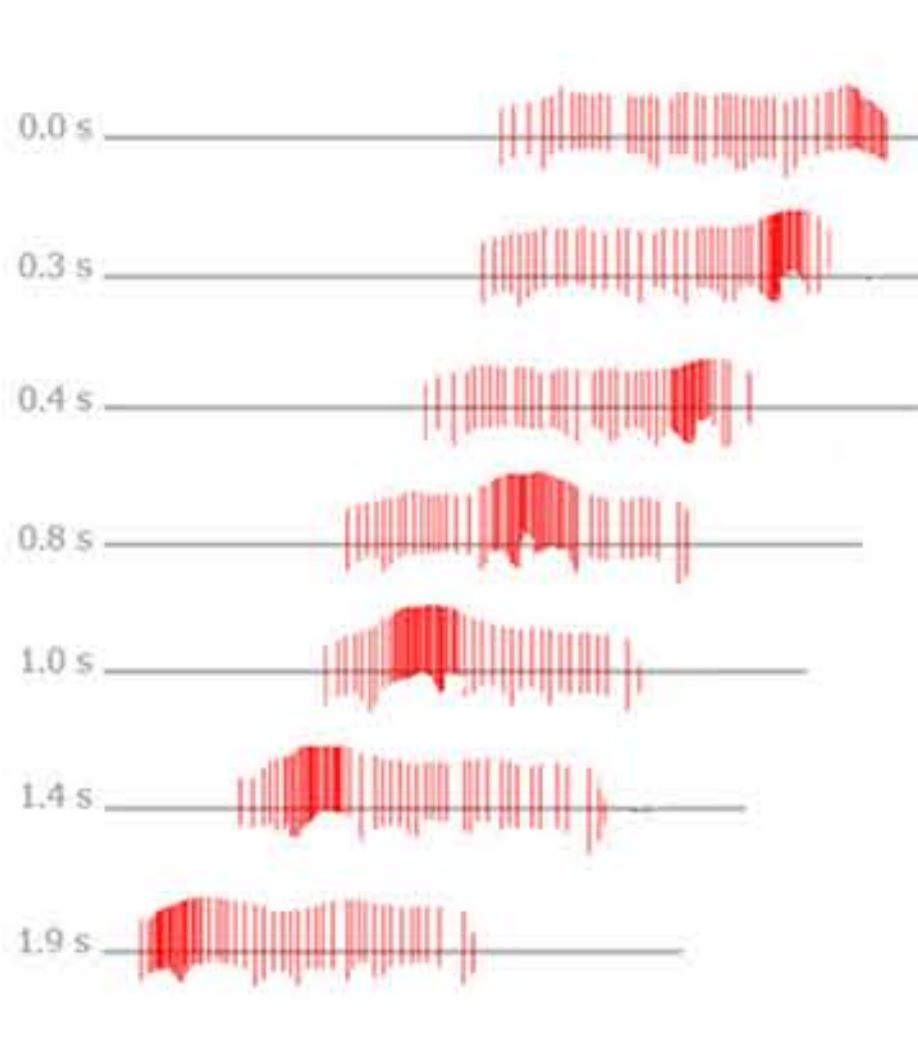

CONTRACCIÓN

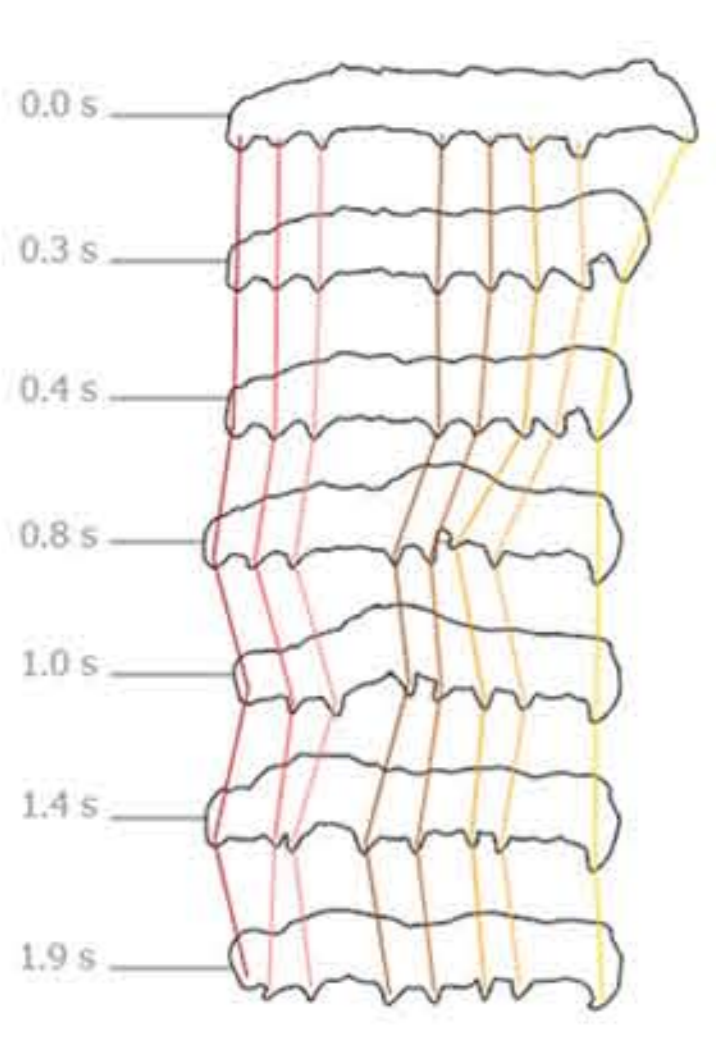

03

RECONOCIMIENTO DE PIEZAS

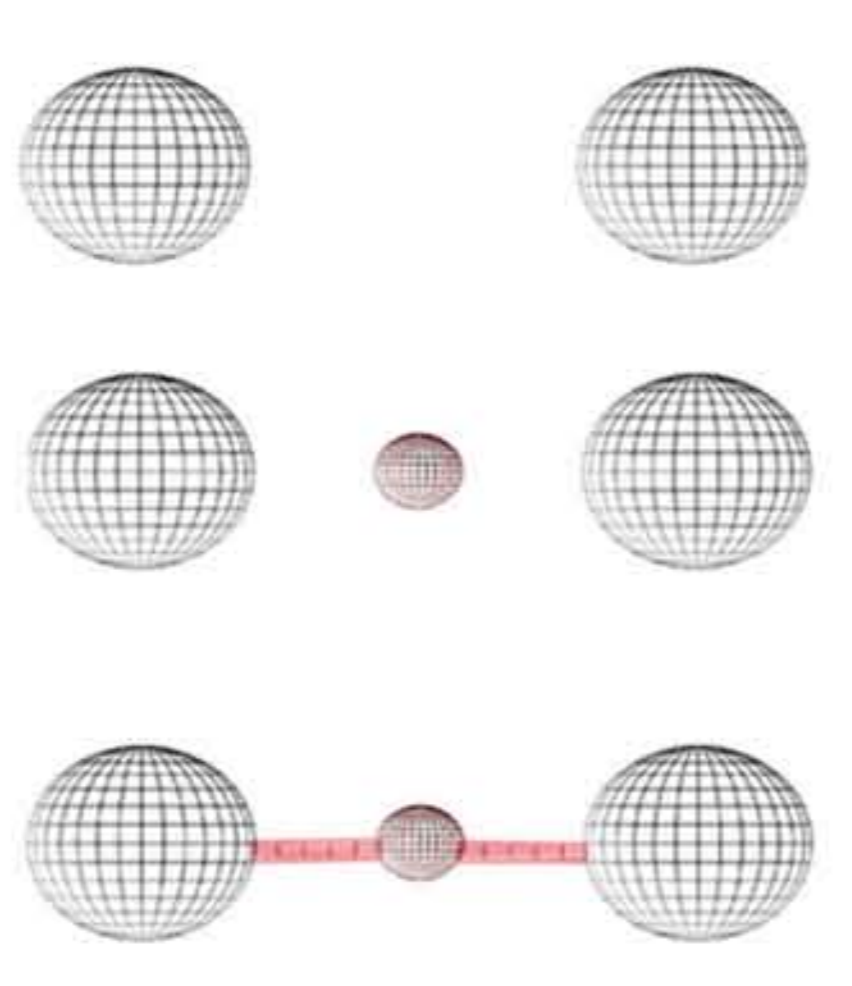

ANÁLISIS MÓDULO

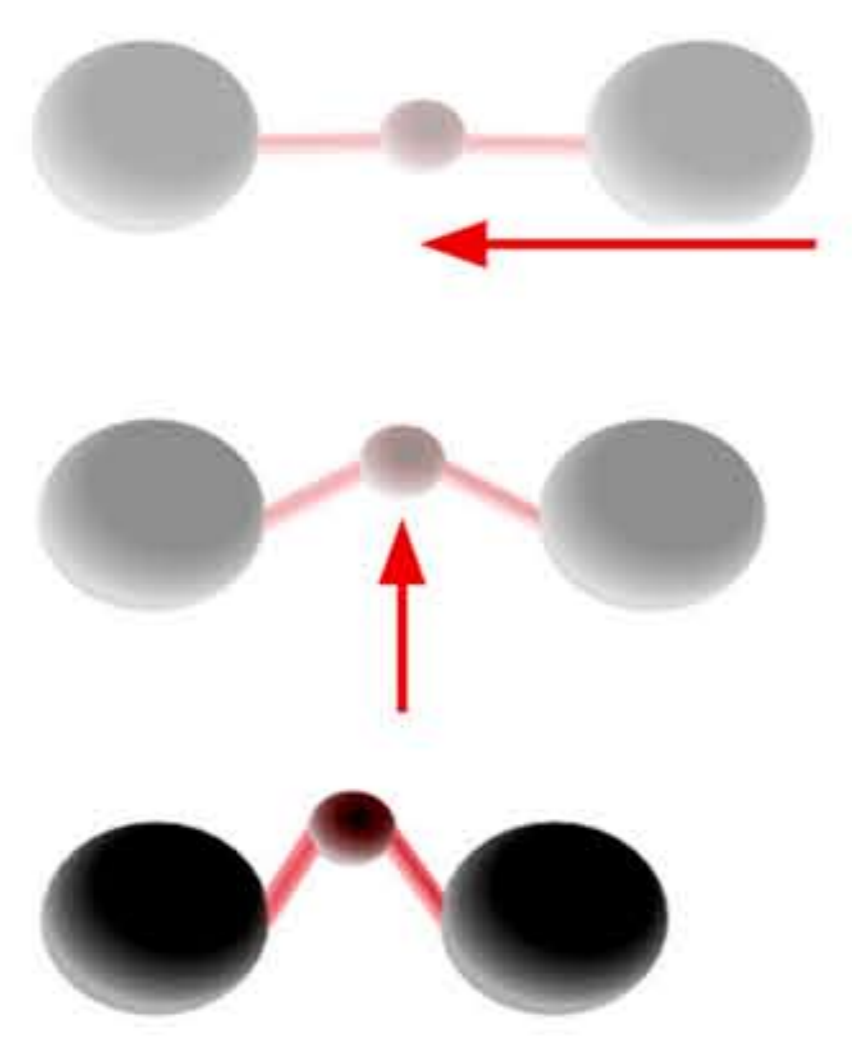

04

MECANISMO DE MOVIMIENTO

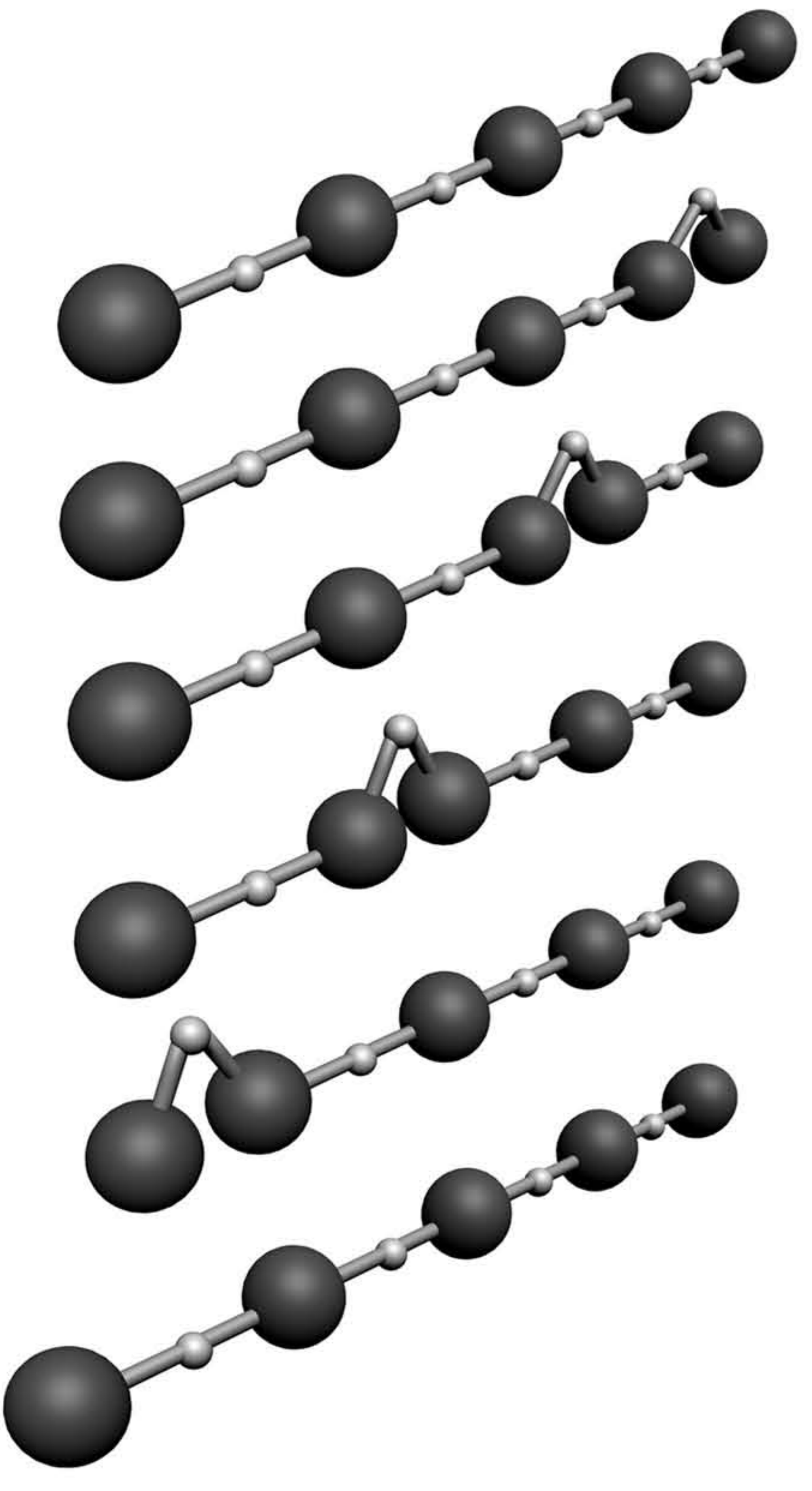

05

TRASPASO

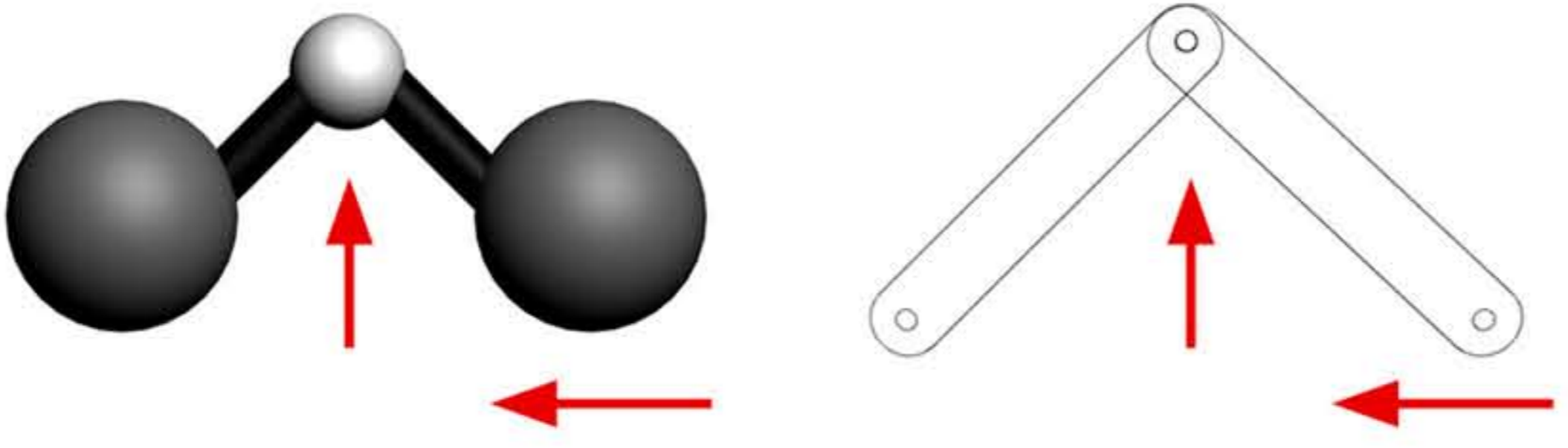

ENSAMBLE PIEZAS

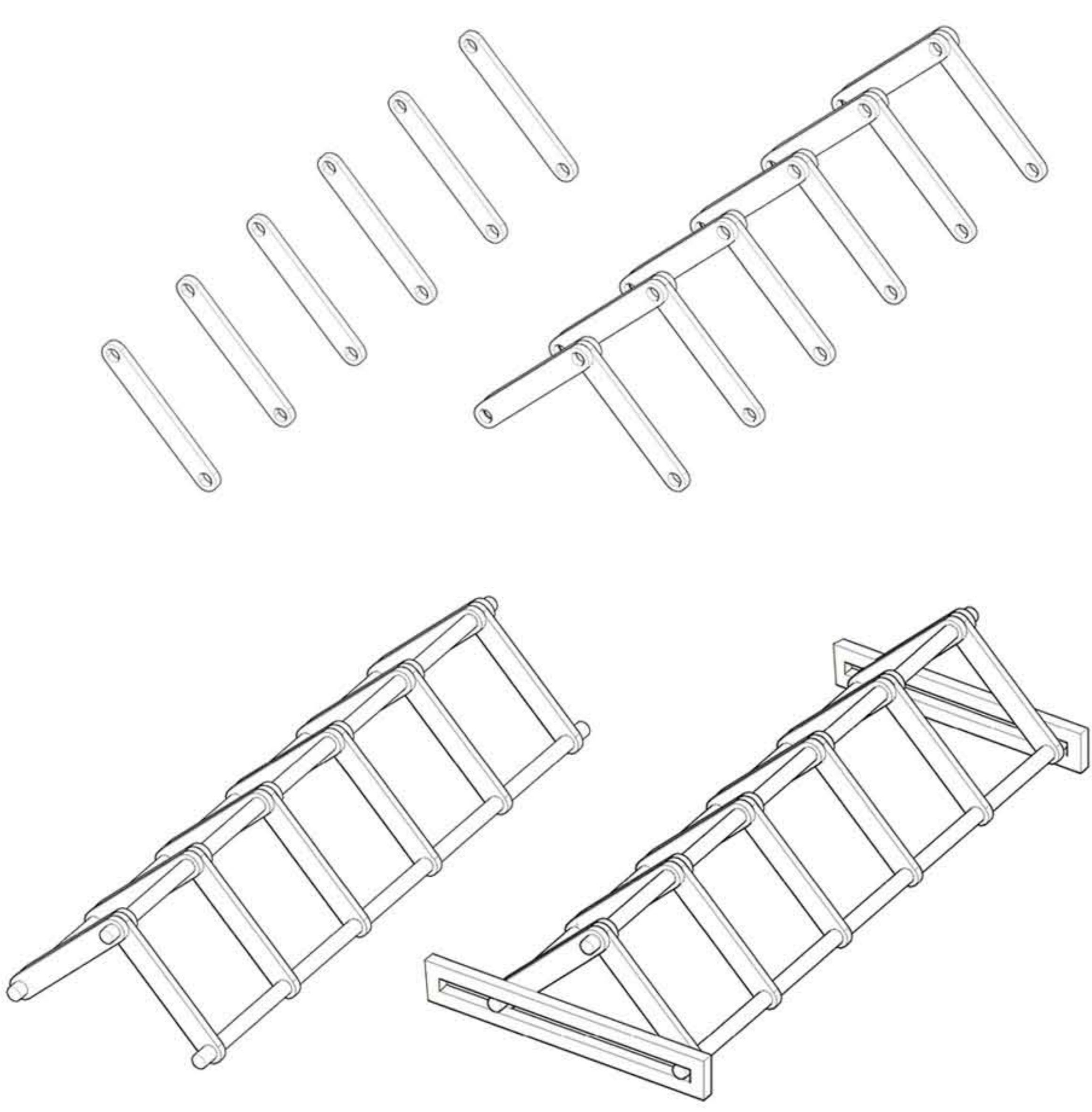

ESTRUCTURA

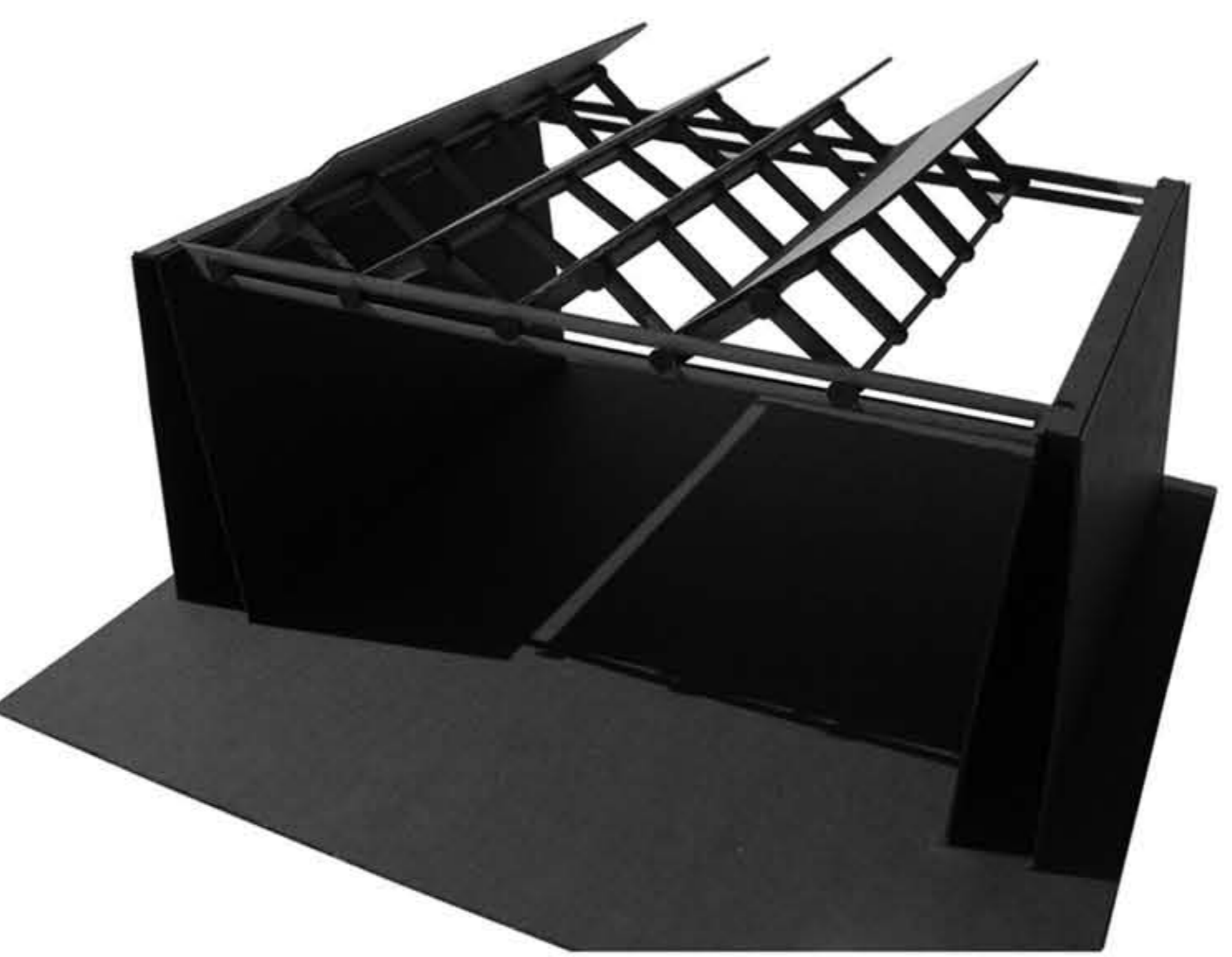
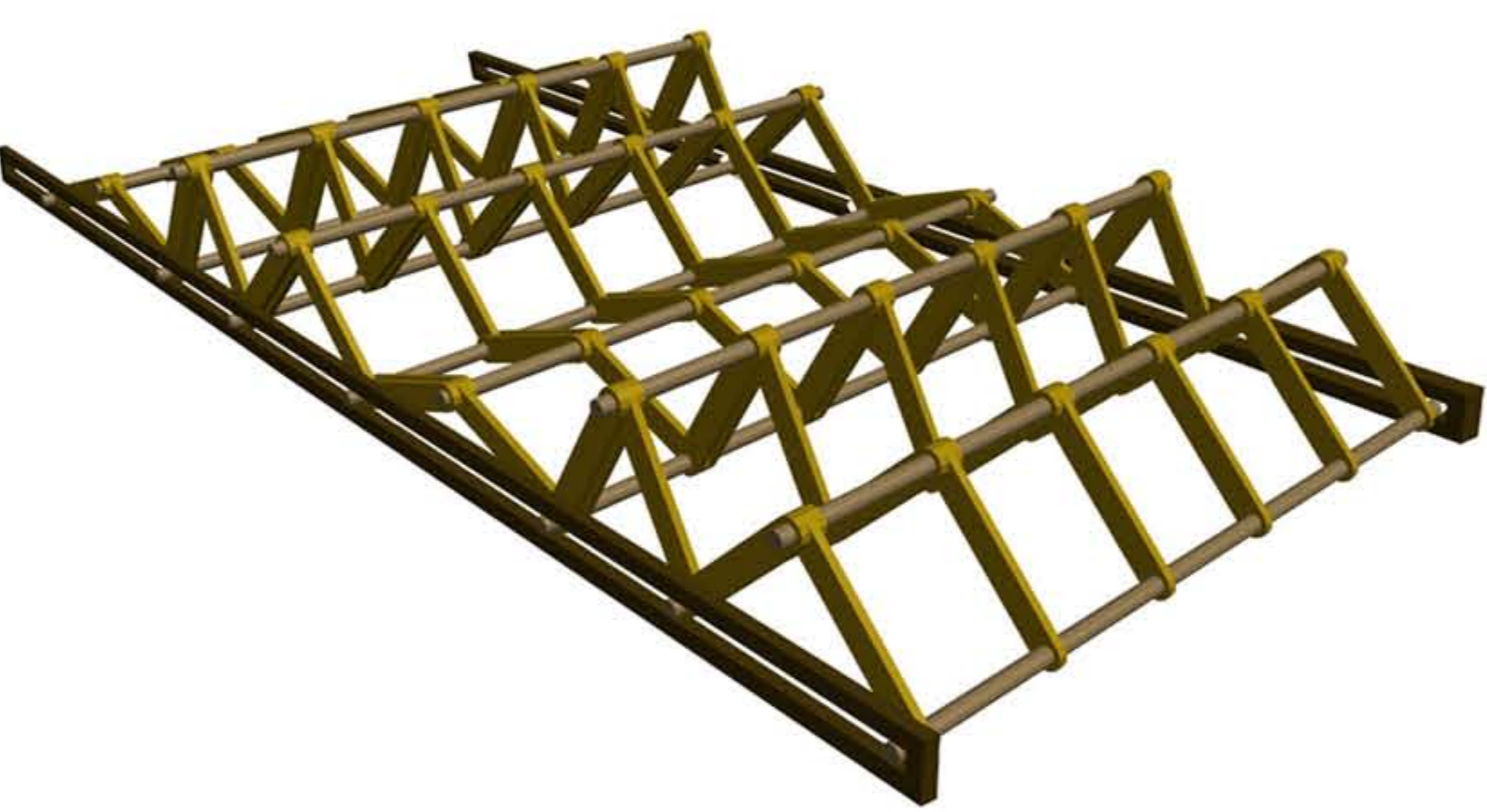

06

PIEL

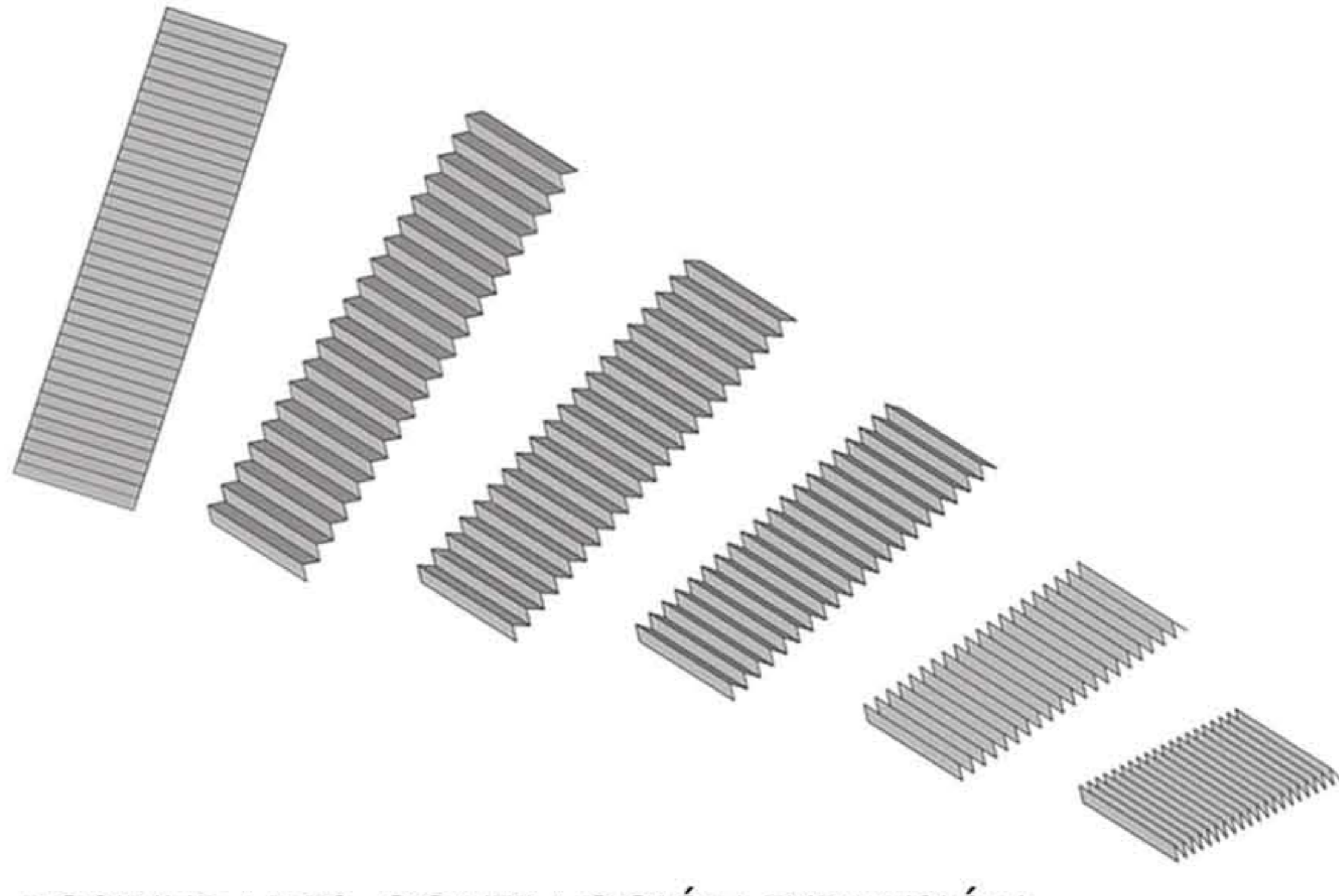

POSIBILIDADES CONTRACCIÓN-EXPANSIÓN

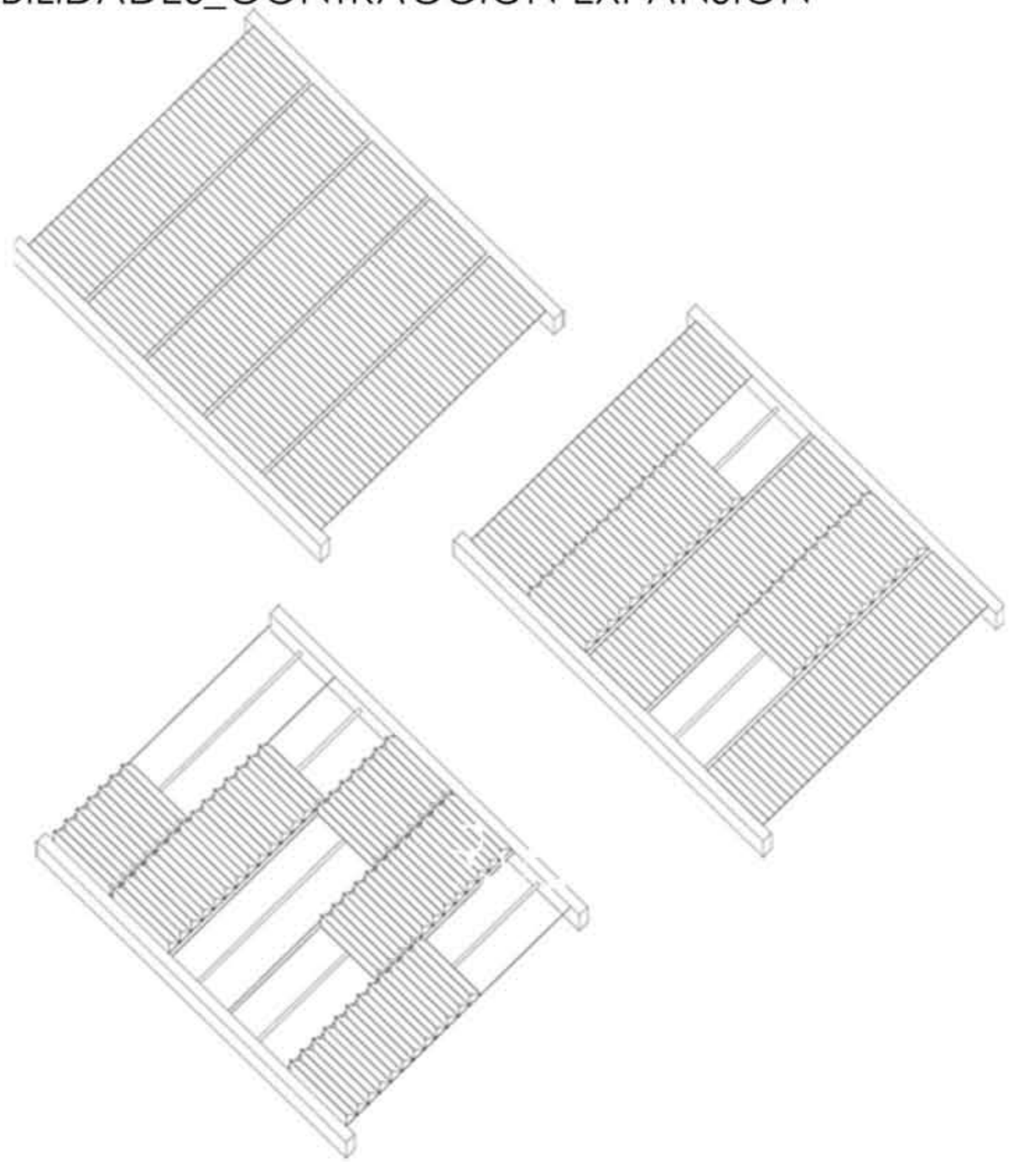

07

ASOCIAR A CADA ÁNGULO EN LA ESTRUCTURA, UNA CONTRACCIÓN EN LA PIEL

